

## Performance of MCBs and auxiliaries

### Breaking capacity in IT neutral earthing system

MCB single pole breaking capacity at 400 V according to IEC 60947-2

DX <sup>3</sup> 6000 10 kA	1P/2P/3P/4P	3 kA
DX <sup>3</sup> 10000 16 kA	1P/2P/3P/4P	4 kA
DX <sup>3</sup> 25 kA	1P/2P/3P/4P	6.25 kA
DX <sup>3</sup> 50 kA	1P/2P/3P/4P	12.5 kA

### Breaking capacity in the event of short-circuit to earth and insulation voltage

	1P/2P/3P/4P 230/400 V~ MCBs			
	DX <sup>3</sup> 6000 10 kA	DX <sup>3</sup> 10000 16 kA	DX <sup>3</sup> 25 kA	DX <sup>3</sup> 50 kA
I <sub>cn1</sub>	10000 A	16000 A	25000 A	50000 A
U <sub>i</sub>	500 V	500 V	500 V	500 V

I<sub>cn1</sub>: Breaking capacity on 1 pole for multipole MCBs in the event of short-circuit to earth  
 U<sub>i</sub>: Rated insulation voltage

### Terminal connection cross-sections (mm<sup>2</sup>)

Copper cable	Rigid		Flexible	
	DX <sup>3</sup> 6000 10 kA	DX <sup>3</sup> 10000 16 kA	DX <sup>3</sup> 25 kA	DX <sup>3</sup> 50 kA
DX <sup>3</sup> 6000 10 kA	35	25		
DX <sup>3</sup> 10000 16 kA	70	50		
DX <sup>3</sup> 25 kA			50	35
DX <sup>3</sup> 36 kA, DX <sup>3</sup> 50 kA and add-on modules				
Auxiliaries	2.5	2.5		

### MCB tripping curves

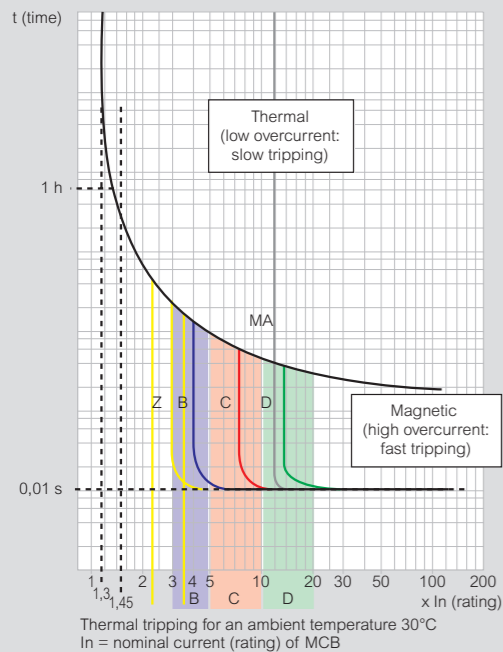

Curves	Magnetic threshold settings
Z <sup>(1)</sup>	2.4 to 3.6 I <sub>n</sub>
B	3 to 5 I <sub>n</sub>
C	5 to 10 I <sub>n</sub>
D	10 to 14 I <sub>n</sub> (10 to 20 acc. to the stds)
MA <sup>(1)</sup>	12 to 14 I <sub>n</sub>

1: On request

### Technical characteristics of auxiliaries

Max. connection cross-section: 2.5 mm<sup>2</sup>  
 Operating temperature: - 25°C to + 70°C

#### Shunt trips

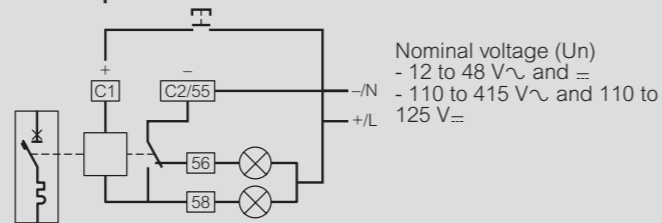

Equipped with a signalling contact which indicates tripping of the shunt trip and automatically breaks the coil.  
 Min. and max. voltage: 0.7 to 1.1 U<sub>n</sub>  
 Tripping time: less than 20 ms  
 Power consumption: at 1.1 x 48 V = 121 VA  
 at 1.1 x 415 V = 127 VA  
 Impedance: 12 to 48 V = 23 Ω  
 110 to 415 V = 1640 Ω

Consumption	U <sub>min.</sub>	U <sub>max.</sub>
12 to 48 V	522 mA	2610 mA
110 to 415 V	69 mA	259 mA

#### Undervoltage releases

Pull-in voltage ≥ 0.55 U<sub>n</sub>  
 Tripping time: 100 to 400 ms ± 10% (adjustable)  
 Power consumption: 24 V~ and =: 0.1 VA  
 48 V~ and =: 0.2 VA  
 230 V~: 1 VA

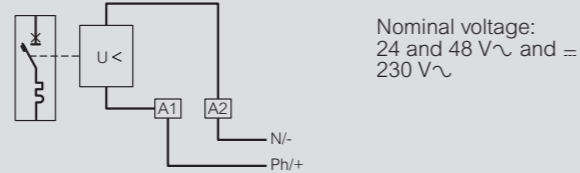

#### Stand-alone releases for N/C push-buttons

Min. and max. operating voltage: 196 to 250 V~  
 Power consumption: 1.4 VA

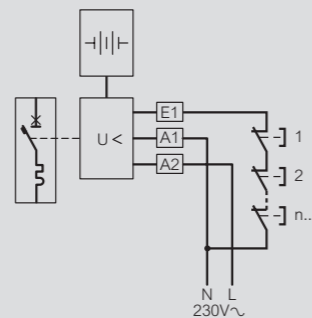

#### Signalling auxiliaries

U<sub>min.</sub>: 24 V~ and = and I<sub>min.</sub>: 5 mA

### Compatibility between auxiliaries on 1 module/pole devices

1 module / pole device (auxiliary on the left side)	1st auxiliary	2nd auxiliary	3rd auxiliary
1st auxiliary	4 062 .. 50/52/56/58/60/62/66/76/78/80/82/84/86/87	-	-
2nd auxiliary	4 062 .. 50/52/56/58/60/62/64/66/	4 062 .. 50/52/56/58/60/62/76/78/80/82/84/86/87	-
3rd auxiliary	4 062 .. 50/52/56/58/60/62	4 062 .. 50/52/56/58/60/62	4 062 .. 76/78/80/82/84/86/87

### Compatibility between auxiliaries on 1.5 module/pole devices

1.5 module / pole device (auxiliary on the left side)	1st auxiliary	2nd auxiliary	3rd auxiliary
1st auxiliary	4 062 .. 50/52/56/58/60/62/66/76/78/80/82/84/86/87	-	-
2nd auxiliary	4 062 .. 50/52/56/58/60/62	4 062 .. 50/52/56/58/60/62/	-
3rd auxiliary	4 062 .. 64/66/	4 062 .. 64/66/	4 062 .. 76/78/80/82/84/86/87

### Performance of add-on modules

#### AC type - Standard applications

Detection of 50-60 Hz AC residual currents

#### A type - Specific applications: dedicated lines

In addition to the characteristics of AC type add-on modules, A type add-on modules also detect residual currents with DC components. They are used whenever the fault currents are not sinusoidal. They are particularly suitable for the following dedicated line applications:

- On circuits where class 1 equipment may produce fault currents with DC components, such as variable speed drives with frequency inverter, etc.

#### Hpi type - Special applications

Hpi add-on modules, with additional immunity to false tripping, which is much higher than the level required by the standard, detect residual currents with AC and DC components (A type), operate between - 25°C and + 40°C, and are used in the following special cases:

- When loss of data would be detrimental, such as computer equipment power supply lines (banks, military instrumentation, airline reservation centres, etc.)

- When loss of operation would be detrimental (automated machines, medical instrumentation, freezer lines, etc.)

- In places where there is a high risk of lightning strikes

- On sites with lines subject to considerable interference (use of fluorescent lights, etc)

- On sites with very long lines

#### Special case of continuity of service

In certain locations where no staff are present and in which continuity of service is particularly important, false tripping of MCBs is not permitted (isolated telephone/TV or radio substations, pumping stations, etc.)

Combining an Hpi RCBO with a motorised control and a STOP & GO recloser provides optimum continuity of service

#### B type

In addition to the characteristics of A type RCDs, B type RCDs also detect smooth DC residual currents

They are used whenever fault currents are not sinusoidal. They are particularly suitable for the following specific applications: speed drives and inverters for supplying motors for pumps, lifts, textile machines, machine tools, photovoltaic installations, call centres, medical equipment, etc.

#### Average residual current performance curves

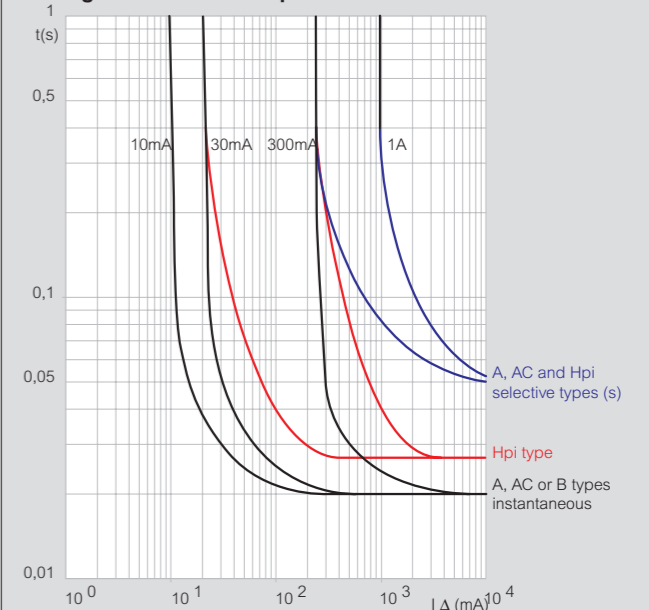

### Residual current breaking capacity of DX<sup>3</sup> add-on modules

I<sub>Δm</sub> according to EN 61009-1  
 AC, A and Hpi add-on modules

DX <sup>3</sup> add-on modules used with an MCB	I <sub>Δm</sub>
DX <sup>3</sup> (1 mod./pole)	6000 A
DX <sup>3</sup> (1.5 mod./pole)	30000 A

# Selectivity tables

MCBs/MCBs (in A)

Upstream MCB		RX <sup>3</sup> 6000 TX <sup>3</sup> 6000 / TX <sup>3</sup> 10000 DX <sup>3</sup> 6000 - 10 kA / DX <sup>3</sup> 10000 - 16 kA B curve										RX <sup>3</sup> 4500 / RX <sup>3</sup> 6000 TX <sup>3</sup> 6000 / TX <sup>3</sup> 10000 DX <sup>3</sup> 6000 - 10 kA / DX <sup>3</sup> 10000 - 16 kA C curve				DX <sup>3</sup> 6000 - 10 kA D curve				DX <sup>3</sup> 25 kA / DX <sup>3</sup> 50 kA C curve					DX <sup>3</sup> 25 kA / DX <sup>3</sup> 50 kA D curve					
Downstream MCB	In (A)	32	40	50	63	32	40	50	63	80	100	125	32	40	50	63	32	40	50	63	80	100	125	32	40	50	63	80	100	125
RX <sup>3</sup> 4500 RX <sup>3</sup> 6000 B & C curves	6	128	160	200	252	240	300	375	472	1300	1600	2000	384	480	600	756	240	300	375	472	1300	1600	2000	384	480	600	756	2000	2400	3000
	10	128	160	200	252	240	300	375	472	1150	1450	1800	384	480	600	756	240	300	375	472	1150	1450	1800	384	480	600	756	1750	2150	2700
	13	128	160	200	252	240	300	375	472	1000	1300	1600	384	480	600	756	240	300	375	472	1000	1300	1600	384	480	600	756	1500	2000	2400
	16	128	160	200	252	240	300	375	472	950	1200	1500	384	480	600	756	240	300	375	472	950	1200	1500	384	480	600	756	1400	1800	2200
	20	128	160	200	252	240	300	375	472	900	1100	1400	384	480	600	756	240	300	375	472	900	1100	1400	384	480	600	756	1350	1650	2100
	25	128	160	200	252	240	300	375	472	850	1000	1300	384	480	600	756	240	300	375	472	850	1000	1300	384	480	600	756	1300	1500	2000
	32	128	160	200	252	240	300	375	472	750	950	1200	384	480	600	756	240	300	375	472	750	950	1200	384	480	600	756	1100	1450	1800
TX <sup>3</sup> 6000 TX <sup>3</sup> 10000 B & C curves	40																													
	50																													
	63																													
	80																													
	100																													
	125																													
	1500																													
DX <sup>3</sup> 6000 - 10 kA B, C & D curves	≤ 6	128	160	200	252	240	300	375	472	4000	T	T	384	480	600	756	700	1200	1500	3000	4000	T	T	700	1200	1500	3000	4000	T	T
	10	128	160	200	252	240	300	375	472	3000	5000	T	384	480	600	756	500	700	1000	1800	3000	5000	T	500	700	1000	1800	3000	5000	T
	13	128	160	200	252	240	300	375	472	2500	4000	6000	384	480	600	756	400	600	1200	1500	2500	4000	6000	400	600	1200	1500	2500	4000	6000
	16	128	160	200	252	240	300	375	472	2000	3600	5500	384	480	600	756	300	500	700	1000	2000	3600	5500	384	500	700	1000	2000	3600	5500
	20	128	160	200	252	240	300	375	472	1600	3000	4000	384	480	600	756	300	400	500	1000	1600	3000	4000	384	480	600	1000	1600	3000	4000
	25	128	160	200	252	240	300	375	472	1300	2400	3300	384	480	600	756	240	400	500	800	1300	2400	3300	384	480	600	800	1300	2400	3300
	32	128	160	200	252	240	300	375	472	1000	1800	2700	384	480	600	756	240	400	500	600	1000	1800	2700	384	480	600	800	1300	2400	3300
DX <sup>3</sup> 10000 - 16 kA B & C curves	40																													
	50																													
	63																													
	80																													
	100																													
	125																													
	1500																													
DX <sup>3</sup> 10000 - 16 kA D curve	≤ 6	128	160	200	252	240	300	375	472	4000	T	T	384	480	600	756	700	1200	1500	3000	4000	T	T	700	1200	1500	3000	4000	T	T
	10	128	160	200	252	240	300	375	472	3000	5000	T	384	480	600	756	500	700	1000	1800	3000	5000	T	500	700	1000	1800	3000	5000	T
	16	128	160	200	252	240	300	375	472	2000	3600	5500	384	480	600	756	300	500	700	1300	2000	3600	5500	384	500	700	1300	2000	3600	5500
	20	128	160	200	252	240	300	375	472	1600	3000	4000	384	480	600	756	300	400	500	1000	1600	3000	4000	384	480	600	1000	1600	3000	4000
	25	128	160	200	252	240	300	375	472	1300	2400	3300	384	480	600	756	240	400	500	800	1300	2400	3300	384	480	600	800	1300	2400	3300
	32	128	160	200	252	240	300	375	472	1000	1800	2700	384	480	600	756	240	400	500	600	1000	1800	2700	384	480	600	800	1300	2400	3300
	40																													
DX <sup>3</sup> 25 kA C curve	50																													
	63																													
	80																													
	100																													
	125																													
	1500																													
	1500																													
DX <sup>3</sup> 25 kA D curve	≤ 6	128	160	200	252	240	300	375	472	4000	T	T	384	480	600	756	700	1200	1500	3000	4000	T	T	700	1200	1500	3000	4000	T	T
	10	128	160	200	252	240	300	375	472	3000	5000	T	384	480	600	756	500	700	1000	1800	3000	5000	T	500	700	1000	1800	3000	5000	T
	16	128	160	200	252	240	300	375	472	2000	3600	5500	384	480	600	756	300	500	700	1300	2000	3600	5500	384	500	700	1300	2000	3600	5500
	20	128	160	200	252	240	300	375	472	1600	3000	4000	384	480	600	756	300	400	500	1000	1600	3000	4000	384	480	600	1000	1600	3000	4000
	25	128	160	200	252	240	300	375	472	1300	2400	3300	384	480	600	756	240	400	500	800	1300	2400	3300	384	480	600	800	1300	2400	3300
	32	128	160	200	252	240	300	375	472	1000	1800	2700	384	480	600	756	240	400	500	600	1000	1800	2700	384	480	600	800	1300	2400	3300
	40																													
DX <sup>3</sup> 50 kA C curve	50																													
	63																													
	80																													
	100																													
	125																													
	1500																													
	1500																													
DX <sup>3</sup> 50 kA D curve	≤ 6	128	160	200	252	240	300	375	472	4000	T	T	384	480	600	756	700	1200	1500	3000	4000	T	T	700	1200	1500	3000	4000	T	T
	10	128	160	200	252	240	300	375	472	3000	5000	T	384	480	600	756	500	700	1000	1800	3000	5000	T	500	700	1000	1800	3000	5000	T
	16	128	160	200	252	240	300	375	472	2000	3600	5500	384	480	600	756	300	500	700	1300	2000	3600	5500	384	500	700	1300	2000	3600	5500
	20	128																												

Back up between MCCBs and MCBs (in kA)

In 3 phases networks + N 400/415 V according to IEC 60947-2

MCBs/MCCBs upstream		DX <sup>3</sup> 10000 16 kA B, C and D curves	DX <sup>3</sup> 25 kA C and D curves	DX <sup>3</sup> 50 kA C and D curves	DPX <sup>3</sup> 160				DPX <sup>3</sup> 250				DPX 250	DPX-H 250	DPX 630	DPX-H 630 DPX-L 630 - 100 kA	DPX 1250 and 1600 + DPX-H 1250 and 1600	
MCBs downstream		10 to 125 A	10 to 125 A	10 to 63 A	16 kA 16 to 160 A	25 kA 16 to 160 A	36 kA 16 to 160 A	50 kA 16 to 160 A	25 kA 40 to 250 A	36 kA 40 to 250 A	50 kA 40 to 250 A	70 kA 40 to 250 A	36 kA 40 to 250 A	70 kA 40 to 250 A	36 kA 250 to 630 A	70 kA 250 to 630 A	50 kA and 70 kA 630 to 1600 A	
DX <sup>3</sup> 6000 - 10 kA B, C and D curves	≤ 20 A	16 kA	25 kA	50 kA	16 kA	25 kA	25 kA	25 kA	25 kA	25 kA	25 kA	25 kA	25 kA	25 kA	25 kA	25 kA	25 kA	25 kA
	25 A	16 kA	25 kA	50 kA	16 kA	25 kA	25 kA	25 kA	25 kA	25 kA	25 kA	25 kA	25 kA	25 kA	25 kA	25 kA	25 kA	20 kA
	32 A	16 kA	25 kA	50 kA	16 kA	25 kA	25 kA	25 kA	25 kA	25 kA	25 kA	25 kA	25 kA	25 kA	25 kA	25 kA	25 kA	15 kA
	40 A	16 kA	25 kA	50 kA	16 kA	25 kA	25 kA	25 kA	25 kA	25 kA	25 kA	25 kA	25 kA	25 kA	25 kA	20 kA	20 kA	15 kA
	50 A	16 kA	25 kA	50 kA	16 kA	25 kA	25 kA	25 kA	25 kA	25 kA	25 kA	25 kA	25 kA	25 kA	25 kA	25 kA	16 kA	16 kA
63 A	16 kA	25 kA	-	16 kA	25 kA	25 kA	25 kA	25 kA	25 kA	25 kA	25 kA	25 kA	25 kA	20 kA	16 kA	16 kA	12,5 kA	
DX <sup>3</sup> 10000 - 16 kA B, C and D curves	≤ 20 A	-	25 kA	50 kA	-	25 kA	25 kA	25 kA	25 kA	25 kA	25 kA	25 kA	25 kA	25 kA	25 kA	25 kA	25 kA	25 kA
	25 A	-	25 kA	50 kA	-	25 kA	25 kA	25 kA	25 kA	25 kA	25 kA	25 kA	25 kA	25 kA	25 kA	25 kA	25 kA	20 kA
	32 A	-	25 kA	50 kA	-	25 kA	25 kA	25 kA	25 kA	25 kA	25 kA	25 kA	25 kA	25 kA	25 kA	25 kA	25 kA	16 kA
	40 A	-	25 kA	50 kA	-	25 kA	25 kA	25 kA	25 kA	25 kA	25 kA	25 kA	25 kA	25 kA	20 kA	20 kA	16 kA	
	50 A	-	25 kA	50 kA	-	25 kA	25 kA	25 kA	25 kA	25 kA	25 kA	25 kA	25 kA	25 kA	20 kA	20 kA	16 kA	
	63 A	-	25 kA	-	-	25 kA	25 kA	25 kA	25 kA	25 kA	25 kA	25 kA	25 kA	20 kA	20 kA	20 kA	16 kA	
DX <sup>3</sup> 25 kA C curve	≤ 25 A	-	-	50 kA	-	-	36 kA	36 kA	-	36 kA	36 kA	25 kA	30 kA	30 kA	30 kA	30 kA	30 kA	
	32 to 50 A	-	-	50 kA	-	-	36 kA	36 kA	-	36 kA	36 kA	25 kA	36 kA	36 kA	36 kA	36 kA	36 kA	
	63 to 80 A	-	-	-	-	-	36 kA	36 kA	-	36 kA	36 kA	36 kA	36 kA	36 kA	36 kA	36 kA	36 kA	
	100 et 125 A	-	-	-	-	-	36 kA	36 kA	-	36 kA	36 kA	36 kA	36 kA	36 kA	36 kA	30 kA	30 kA	
DX <sup>3</sup> 25 kA D curve	≤ 10 A	-	-	50 kA	-	-	36 kA	36 kA	-	36 kA	36 kA	36 kA	30 kA	30 kA	30 kA	30 kA	30 kA	
	16 to 63 A	-	-	50 kA	-	-	36 kA	36 kA	-	36 kA	36 kA	36 kA	36 kA	36 kA	36 kA	36 kA	36 kA	
DX <sup>3</sup> 50 kA C and D curves	10 to 63 A	-	-	-	-	-	-	-	-	-	-	70 kA	-	70 kA	-	70 kA	70 kA	

In 3 phases networks + N 230/240 V according to IEC 60947-2

MCBs/MCCBs upstream		DX <sup>3</sup> 10000 16 kA B, C and D curves		DX <sup>3</sup> 25 kA C and D curves		DX <sup>3</sup> 50 kA C curves		DX <sup>3</sup> 50 kA D curves		DPX <sup>3</sup> 160				DPX <sup>3</sup> 250				DPX 250	DPX-H 250	DPX 630	DPX-H 630 DPX-L 630 - 100 kA	DPX 1250 and 1600 + DPX-H 1250 and 1600		
MCBs downstream		≤ 32 A	40 to 125 A	≤ 32 A	40 to 125 A	≤ 32 A	40 to 63 A	≤ 32 A	40 to 63 A	16 kA 16 to 160 A	25 kA 16 to 160 A	36 kA 16 to 160 A	50 kA 16 to 160 A	25 kA 40 to 250 A	36 kA 40 to 250 A	50 kA 40 to 250 A	70 kA 40 to 250 A	36 kA 40 to 250 A	70 kA 40 to 250 A	36 kA 250 to 630 A	70 kA 250 to 630 A	50 kA + 70 kA 630 to 1600 A		
DX <sup>3</sup> 6000 - 10 kA B, C and D curves	≤ 20 A	32 kA	25 kA	50 kA	25 kA	50 kA	50 kA	50 kA	50 kA	28 kA	40 kA	50 kA	50 kA	40 kA	50 kA	50 kA	50 kA	50 kA	50 kA	50 kA	50 kA	50 kA	50 kA	50 kA
	25 to 40 A	-	25 kA	-	25 kA	-	50 kA	-	50 kA	28 kA	40 kA	50 kA	50 kA	40 kA	50 kA	50 kA	50 kA	50 kA	50 kA	50 kA	50 kA	50 kA	50 kA	50 kA
	50 A	-	25 kA	-	25 kA	-	-	-	-	28 kA	40 kA	50 kA	50 kA	40 kA	50 kA	50 kA	50 kA	50 kA	50 kA	50 kA	50 kA	30 kA	30 kA	25 kA
	63 A	-	25 kA	-	25 kA	-	-	-	-	28 kA	40 kA	50 kA	50 kA	40 kA	50 kA	50 kA	50 kA	50 kA	50 kA	50 kA	50 kA	30 kA	30 kA	25 kA
DX <sup>3</sup> 10000 - 16 kA B, C and D curves	≤ 20 A	-	-	50 kA	32 kA	70 kA	70 kA	70 kA	70 kA	35 kA	40 kA	50 kA	50 kA	40 kA	50 kA	50 kA	50 kA	50 kA	50 kA	50 kA	50 kA	50 kA	50 kA	50 kA
	25 to 40 A	-	-	-	32 kA	-	70 kA	-	70 kA	35 kA	40 kA	50 kA	50 kA	40 kA	50 kA	50 kA	50 kA	50 kA	50 kA	50 kA	50 kA	50 kA	50 kA	50 kA
	50 et 63 A	-	-	-	32 kA	-	-	-	-	35 kA	40 kA	50 kA	50 kA	40 kA	50 kA	50 kA	50 kA	50 kA	50 kA	50 kA	50 kA	36 kA	36 kA	36 kA
	80 to 125 A	-	-	-	-	-	-	-	-	35 kA	40 kA	50 kA	50 kA	40 kA	50 kA	50 kA	50 kA	50 kA	50 kA	50 kA	50 kA	32 kA	32 kA	32 kA
DX <sup>3</sup> 25 kA C and D curves	≤ 25 A	-	-	-	-	70 kA	70 kA	70 kA	70 kA	-	-	-	55 kA	-	-	60 kA	60 kA	55 kA	60 kA	55 kA	60 kA	55 kA	60 kA	50 kA
	32 to 125 A	-	-	-	-	-	70 kA	-	70 kA	-	-	-	65 kA	-	-	60 kA	60 kA	55 kA	60 kA	55 kA	60 kA	55 kA	60 kA	50 kA
DX <sup>3</sup> 25 kA D curves	≤ 10 A	-	-	-	-	70 kA	70 kA	70 kA	70 kA	-	-	-	55 kA	-	-	60 kA	60 kA	55 kA	60 kA	55 kA	60 kA	55 kA	60 kA	50 kA
	16 to 63 A	-	-	-	-	70 kA	70 kA	70 kA	70 kA	-	-	-	65 kA	-	-	60 kA	60 kA	55 kA	60 kA	55 kA	60 kA	55 kA	60 kA	50 kA
DX <sup>3</sup> 50 kA C and D curves	10 to 63 A	-	-	-	-	-	-	-	-	-	-	-	-	-	-	-	-	120 kA	-	120 kA	-	120 kA	120 kA	

TT or TN neutral earthing systems:  
For a 230/400 V supply in order to determine the breaking capacity of a 2 P MCB used as L + N (230 V) downstream a 2 P or 4 P circuit breaker use values indicated in the table for 230/240 V

# Protection of DC circuits

## Protection of DC circuits

DX<sup>3</sup> MCBs (1P/2P/3P/4P -  $I_n \leq 63$  A) designed for use in 230/400 V~ supplies, can also be used in DC circuits. In this case, the following deratings and precautions must be taken into account

### 1 - Protection against short-circuits

Max. magnetic tripping threshold: multiplied by 1.4  
 Example: For a C curve MCB for which the AC tripping threshold is between 5 and 10  $I_n$ , the DC tripping threshold will be between 7 and 14  $I_n$

### 2 - Protection against overloads

The time/current thermal tripping curve is the same as for AC

### 3 - Operating voltage

Min. operating voltage: 12 V<sub>DC</sub>  
 Max. operating voltage: 60 V<sub>DC</sub> for single-pole MCBs  
 For voltages higher than this value, several poles must be wired in series as follows

Number of poles	1 P	2 P	3 P	4 P
Max. operating voltage (V)	60	110	150	180

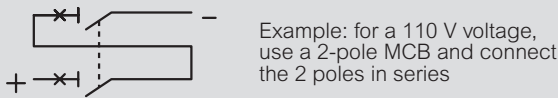

### 4 - Wiring modes

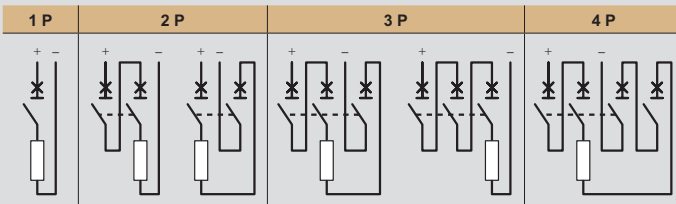

### 5 - Breaking capacity

According to IEC 60947.2		DC Voltage (V)	1P	2P	3P	4P
DX <sup>3</sup> 4500 / 6 kA B and C curves $I_n \leq 63$ A	Icu	12 to 60	4.5 kA	4.5 kA	4.5 kA	4.5 kA
		110		4.5 kA	4.5 kA	4.5 kA
		150			4.5 kA	4.5 kA
	Ics <sup>(1)</sup>	12 to 60	100%	100%	100%	100%
		110		100%	100%	100%
		150			100%	100%
DX <sup>3</sup> 6000 / 10 kA B and C curves $I_n \leq 63$ A	Icu	12 to 60	6 kA	6 kA	6 kA	6 kA
		110		6 kA	6 kA	6 kA
		150			6 kA	6 kA
	Ics <sup>(1)</sup>	12 to 60	100%	100%	100%	100%
		110		100%	100%	100%
		150			100%	100%
DX <sup>3</sup> 10000 / 16 kA B and C curves $I_n \leq 63$ A	Icu	12 to 60	10 kA	10 kA	10 kA	10 kA
		110		10 kA	10 kA	10 kA
		150			10 kA	10 kA
	Ics <sup>(1)</sup>	12 to 60	100%	100%	100%	100%
		110		100%	100%	100%
		150			100%	100%
DX <sup>3</sup> 25 kA B and C curves $I_n \leq 25$ A	Icu	12 to 60	16 kA	16 kA	16 kA	16 kA
		110		16 kA	16 kA	16 kA
		150			16 kA	16 kA
	Ics <sup>(1)</sup>	12 to 60	100%	100%	100%	100%
		110		100%	100%	100%
		150			100%	100%
DX <sup>3</sup> 6000 / 10 kA B and C curves $I_n \leq 25$ A	Icu	12 to 60	16 kA	16 kA	16 kA	16 kA
		110		16 kA	16 kA	16 kA
		150			16 kA	16 kA
	Ics <sup>(1)</sup>	12 to 60	100%	100%	100%	100%
		110		100%	100%	100%
		150			100%	100%

1: As a % of Icu

### 6 - Distribution of breaking poles

To choose the MCB and determine the pole distribution necessary for breaking on each of the polarities, it is necessary to know how the installation is earthed

#### • Supply with one polarity earthed:

Place all the poles necessary for breaking on the other polarity. If isolation is required, an additional pole must be added on the earthed polarity

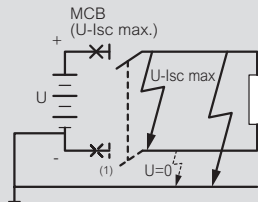

Example: circuit earthed via the negative polarity /  $U = 110$  V<sub>DC</sub> /  $I_{sc} = 10$  kA /  $I_n = 32$  A

Protect the positive polarity using an MCB capable of breaking 10 kA at 110 V (DX<sup>3</sup> 10000 2P 32 A with 2 poles on the positive polarity)  
 For isolation, use a DX<sup>3</sup> 10000 3P 32 A with 2 poles on the positive polarity and one pole on the negative polarity

DX <sup>3</sup> 10000 / 16 kA	DC Voltage (V)	1P	2P	3P	4P	
Acc. To IEC 60947.2	Icu	12 to 60	10 kA	10 kA	10 kA	10 kA
		110		10 kA	10 kA	10 kA
		150			10 kA	10 kA
		180				10 kA

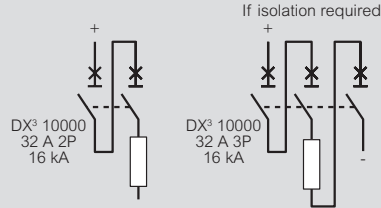

#### • Network earthed via a middle point:

Place on each polarity the number of poles necessary for max.  $I_{sc}$  breaking at half voltage

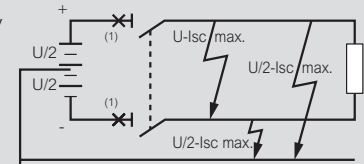

Example:

Circuit earthed via a middle point /  $U = 220$  V<sub>DC</sub> /  $I_{sc} = 6$  kA /  $I_n = 10$  A  
 Protect each polarity using an MCB capable of breaking 6 kA at half voltage, i.e. 110 V (DX<sup>3</sup> 6000 4P 10 A with 2 poles on each polarity)

DX <sup>3</sup> 6000 / 10 kA	DC Voltage (V)	1P	2P	3P	4P	
Acc. To IEC 60947.2	Icu	12 to 60	6 kA	6 kA	6 kA	6 kA
		110		6 kA	6 kA	6 kA
		150			6 kA	6 kA
		180				6 kA

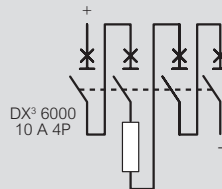

#### • Isolated earth supply:

Distribute the poles necessary for breaking over the 2 polarities to provide protection in the event of a double earth fault (particularly if there are a number of circuits in parallel)

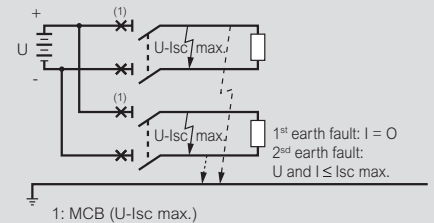

Example: isolated earth circuit /  $U = 48$  V<sub>DC</sub> /  $I_{sc} = 6$  kA /  $I_n = 40$  A  
 Protect the installation with an MCB capable of breaking 6 kA at 48 V and protect each polarity (DX<sup>3</sup> 6000 MCB 2P 40 A with one pole on each polarity)

DX <sup>3</sup> 6000 / 10 kA	DC Voltage (V)	1P	2P	3P	4P	
Acc. To IEC 60947.2	Icu	12 to 60	6 kA	6 kA	6 kA	6 kA
		110		6 kA	6 kA	6 kA
		150			6 kA	6 kA
		180				6 kA

